

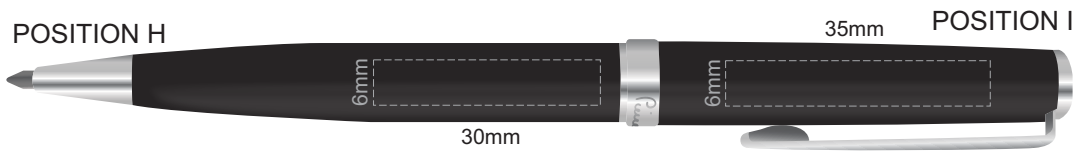

100% of Actual Size  
Pad Print

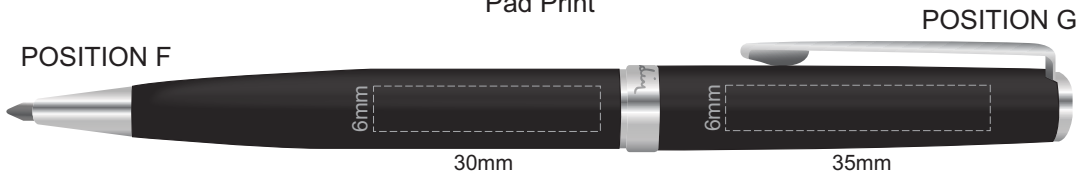

100% of Actual Size  
Laser Engraving

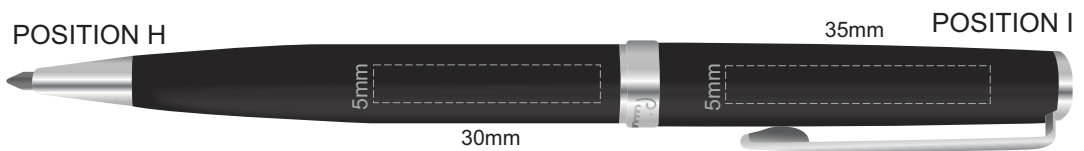
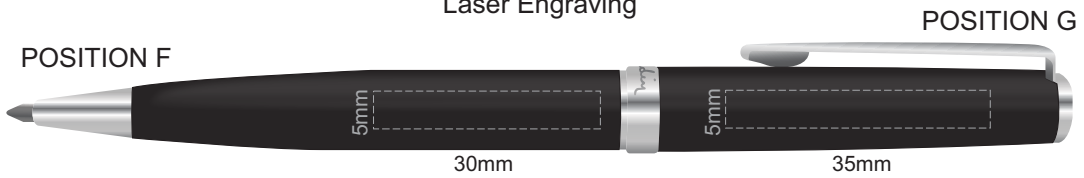

Engraves to a Silver mirror finish

100% of Actual Size  
Pad Print

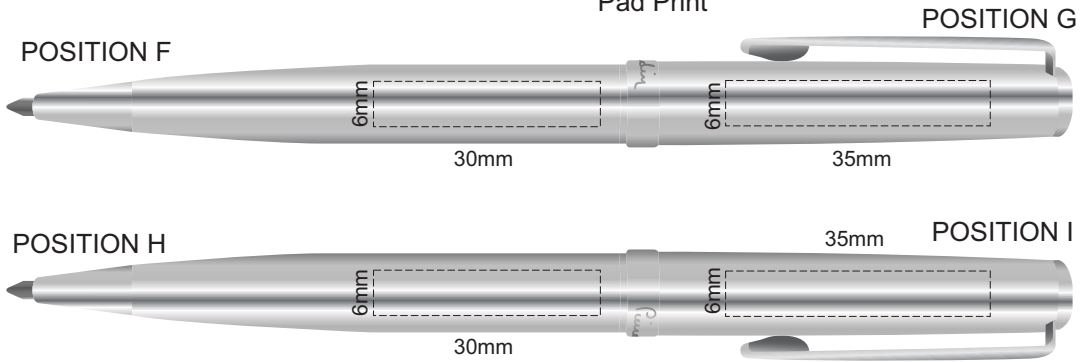

100% of Actual Size  
Laser Engraving

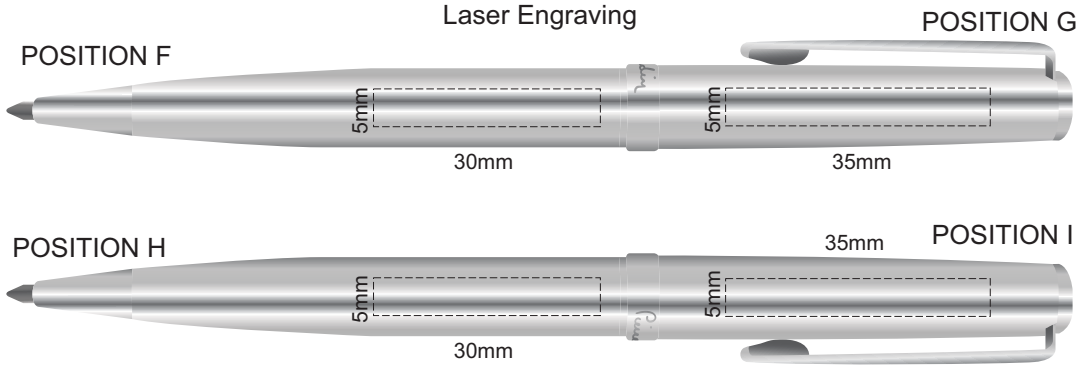

Chrome engraves to a Silver Natural Etch

100% of Actual Size  
Pad Print

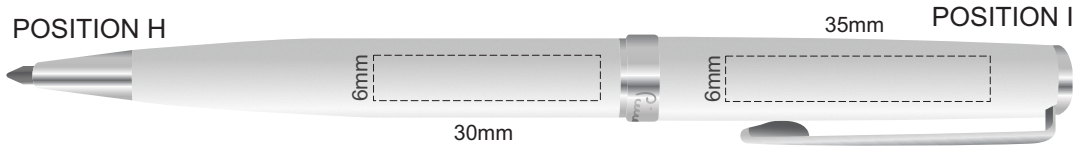
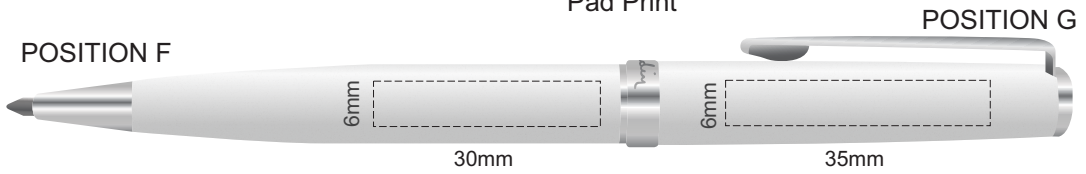

100% of Actual Size  
Laser Engraving

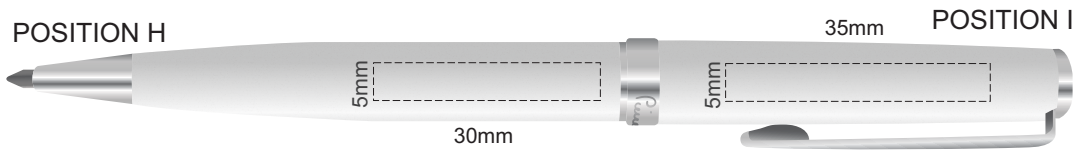
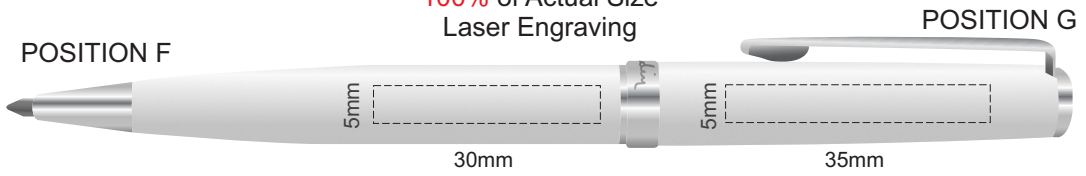

■ Matt Silver engraves to a Silver Natural Etch



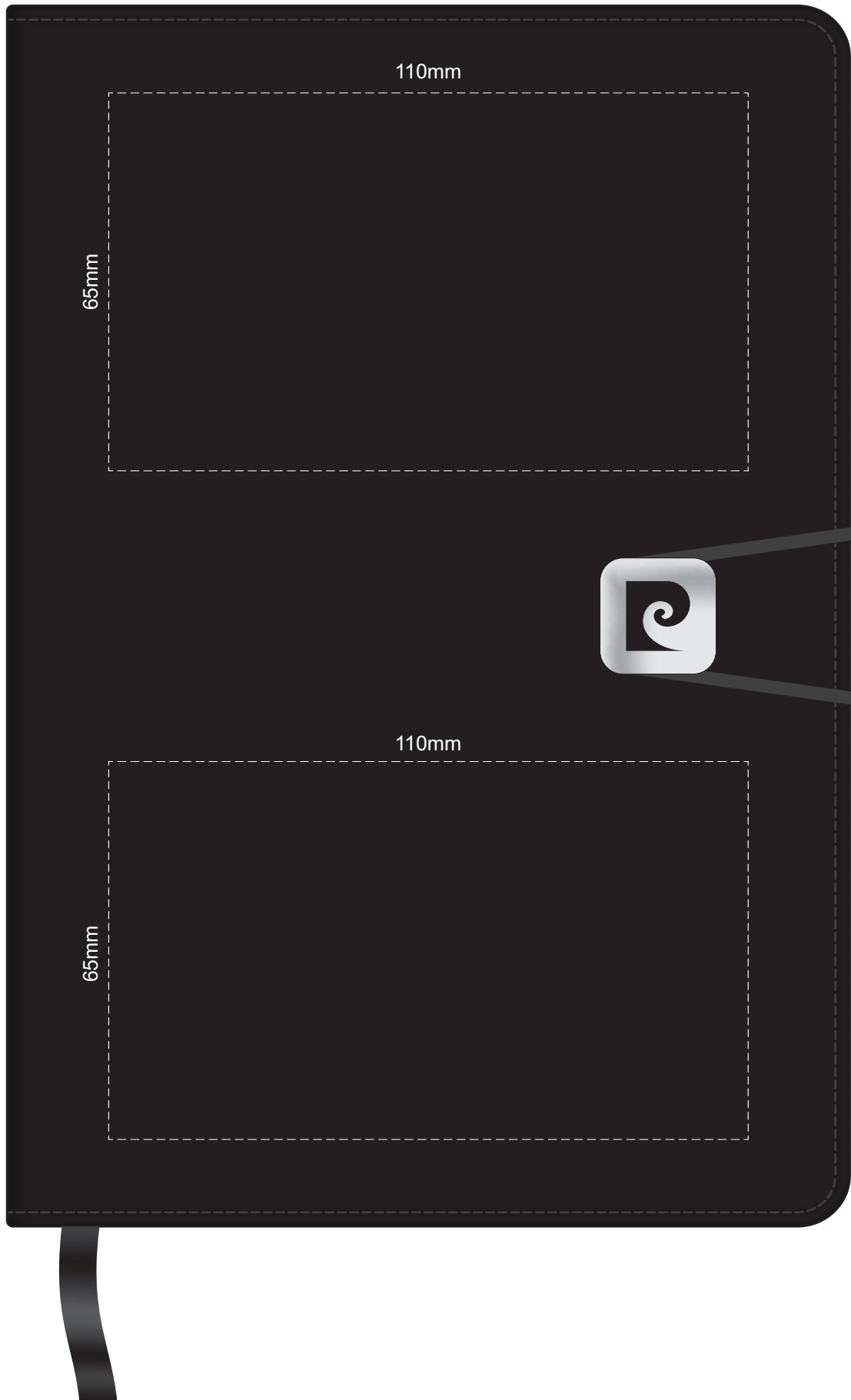

100% of Actual Size  
Thermo Debossing (Front)

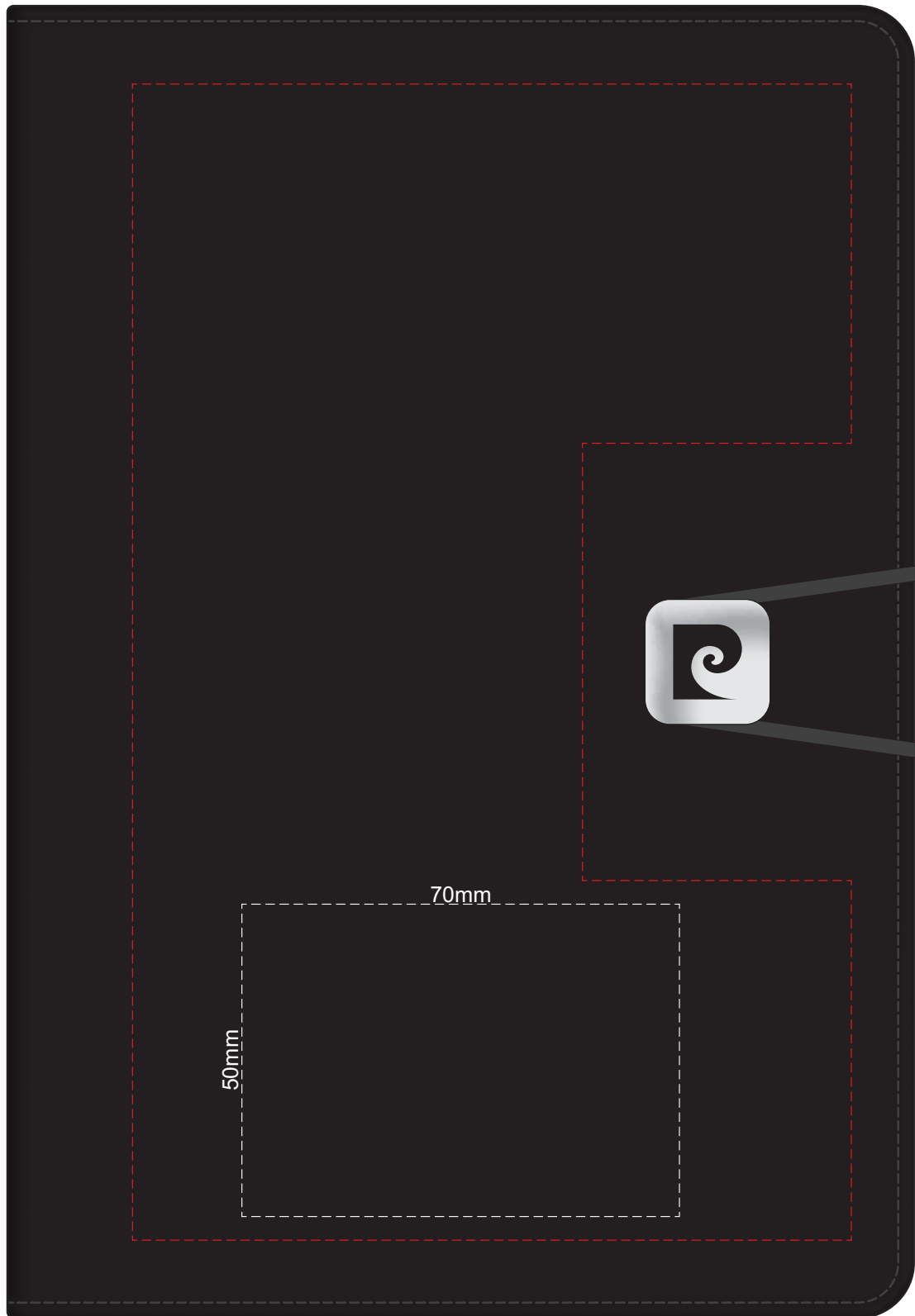

100% of Actual Size  
Foil Printing Front Cover  
FRONT ONLY



Please note: Print area 70mm x 50mm is **moveable within the red dotted area**, the print area cannot be rotated. The printing will inherit the texture of the substrate which may affect the legibility of small text or appearance of fine detail.

-  Copper Foil Print Colour
-  Silver Foil Print Colour
-  Gold Foil Print Colour